

# GENERAL-PURPOSE LIMIT SWITCH

TYPE:LL

10A 125,250,480VAC AC  
 1/21-P 125VAC 1 1-P 250V  
 0.8A 125VDC 0.4A 250V DC  
 0.1A 600VDC

## CONTACT CONFIGURATION

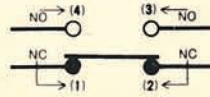

### ● LL-GL

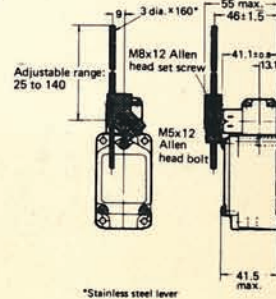

### ● LL-D

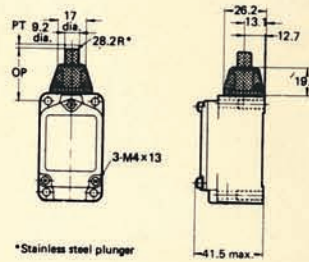

### ● LL-D2

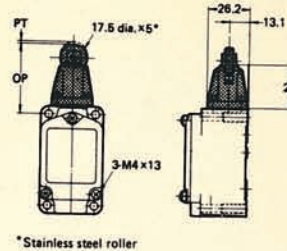

### ● LL-CA2

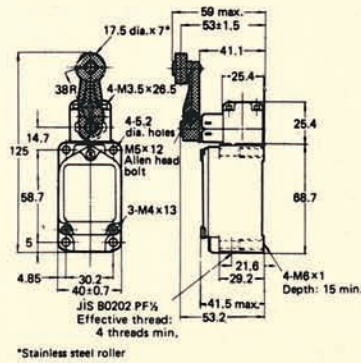

### ● LL-NJ

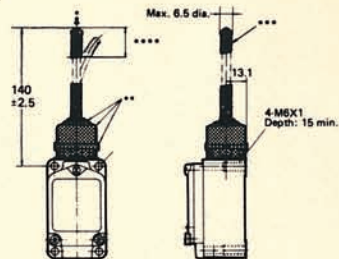

### ● LL-CA12

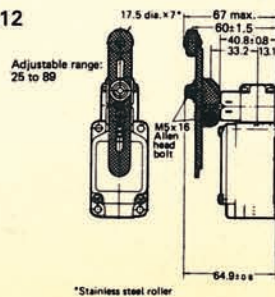

## OVERTRAVEL TYPE

The Overtravel Type is a limit switch which is provided with a greater OT to facilitate dog setting. Since this type is identical to the Basic Type in dimensions, both types are interchangeable.

The Overtravel Type is classified into two versions -2 series and -2N series.

Mounting holes

Basic type

